

# NOVA LUCE

9756722, 9756723

1

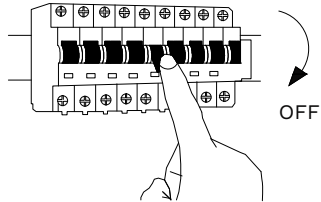

Turn off the general switch

2

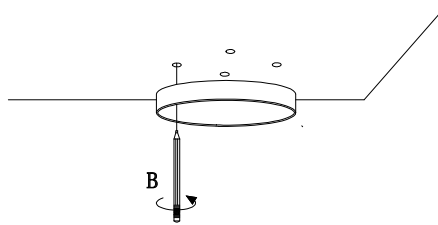

Mark where to drill holes

3

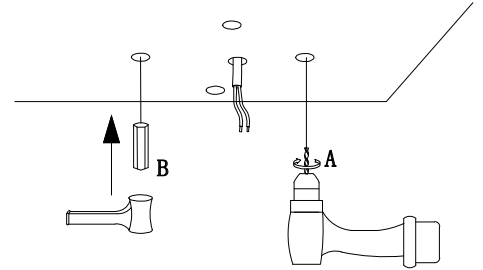

Make holes & apply anchors

4

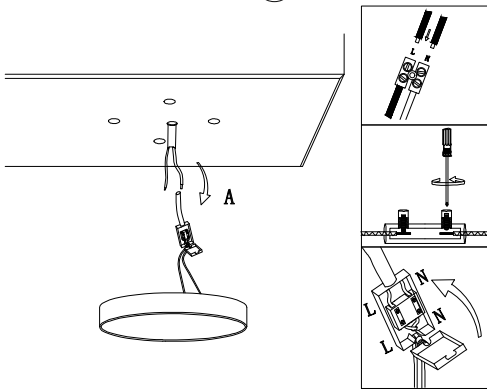

Connect the wires

5

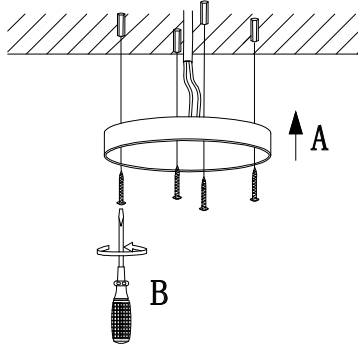

Tie up the screws to make it stable

6

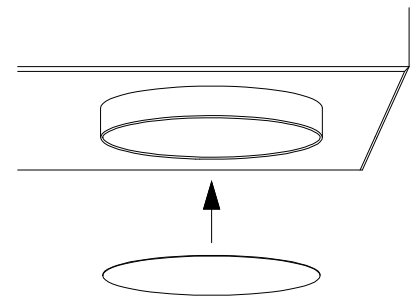

Fix the cap onto place

7

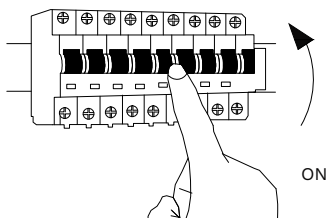

Turn on the general switch



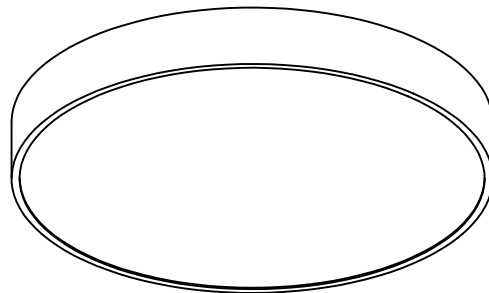



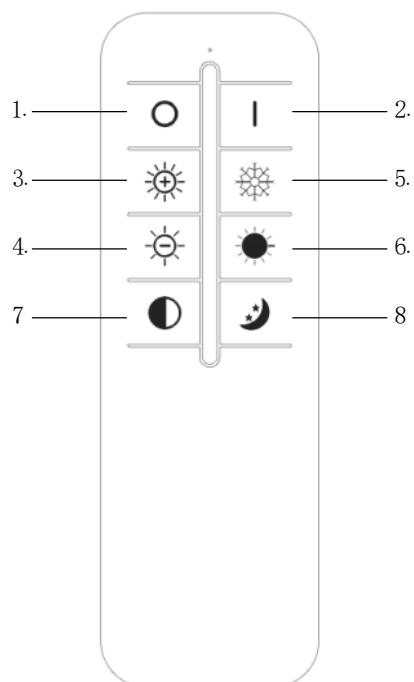

8



# NOVA LUCE

## Remote control instructions



1.  Turn off the light.
2.  Turn on the light.
3.  Increase brightness.
4.  Decrease brightness.
5.  Increase the color temperature.
6.  Decrease the color temperature.
7.  Switch the color temperature.
8.  Switch to sleeping mode.

