

1

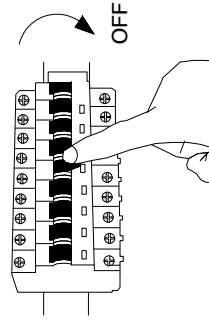

Turn off the general switch

2

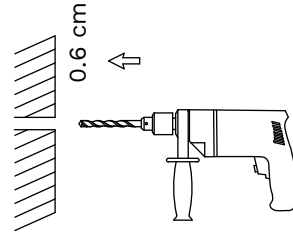

Drill holes

3

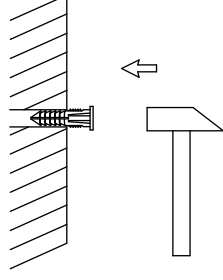

Apply plastic anchors

4

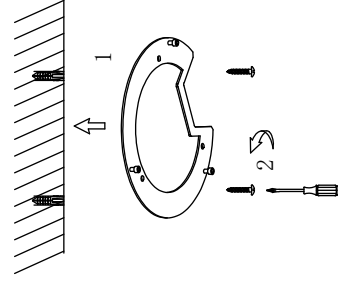

Tie up screws to fix it in place

5

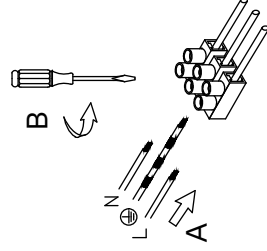

Connect wires

6

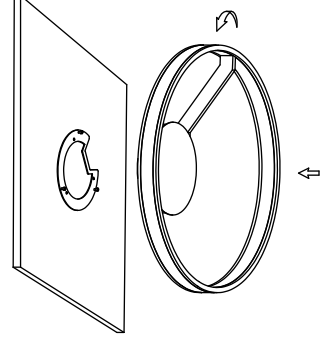

Tie up side screws to make it stable

7

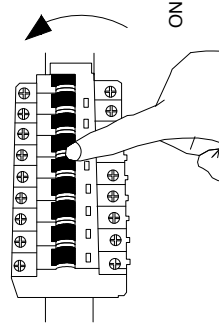

Turn on the general switch

