

NOVA LUCE

PRODUCT DATASHEET

Version: 001

PRODUCT PHOTOGRAPH



TECHNICAL DRAWING

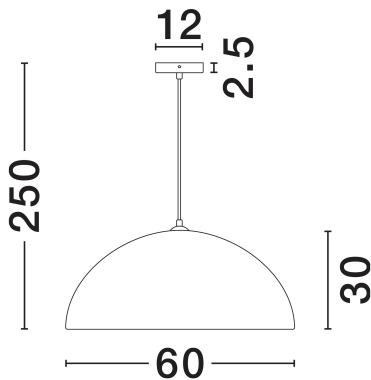

GENERAL INFORMATION

Product Code	9002683
Collection	Indoor
Product Category	Suspension
Product Family	Starla
Mounting Location	Wall
Application Environment	Indoor
Specifications	N/A

DIMENSION & WEIGHT

LxWxH (cm)	D: 60 H: 250
Cut Out (cm)	N/A
Weight (Kgr)	2.8

MATERIAL & COLOR

Product Color	Stone Gray
Body Material	Polyurethane & Resin

APPLICATION & MOUNTING

Ambient Working Temp.	Max 45°C
Type of Protection	IP20
Dimmable	N/A
Type of Dimming	N/A
Mounting type	Surface
Mounting Depth (cm)	N/A
Led Module Replaceable	Yes
Light Source	E27

NOVA LUCE S.A

Schimatari Viotias
32009, Greece

+30 22620 58 121
+30 22620 56 743

info@novaluce.com
www.novaluce.com



NOVA LUCE

PRODUCT DATASHEET

Version: 001

ELECTRICAL DATA

Power (Nominal)	1x12W
Input voltage (Nominal)	220-240V
Mains Frequency	50/60Hz

PHOTOMETRICAL DATA

Luminous Flux	N/A
Color Temperature	N/A
Light Color (Designation)	N/A

WARRANTY

Warranty	3 Years
----------	----------------

CERTIFICATES

Certificates	CE,UKCA
--------------	----------------

