

NOVA LUCE

9136444

1

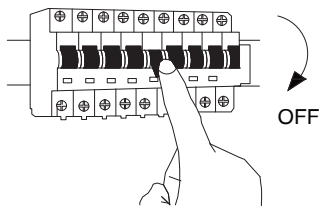

Turn off the general switch

2

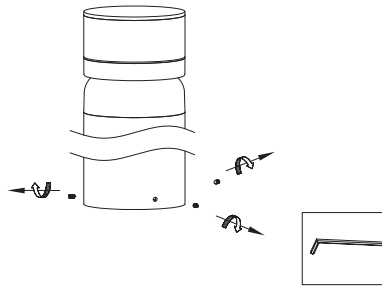

Dismantle parts by untying screws

3

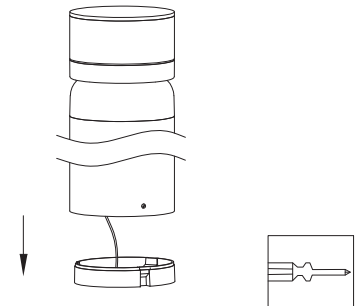

Remove from the base

4

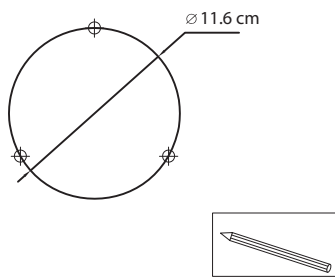

Mark holes

5

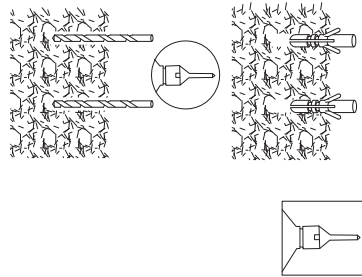

Drill holes & apply anchors

6

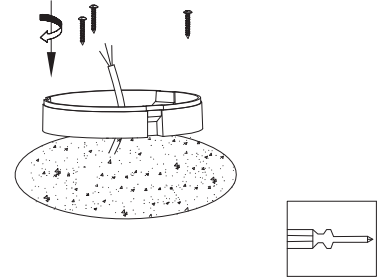

Tie up screws

7

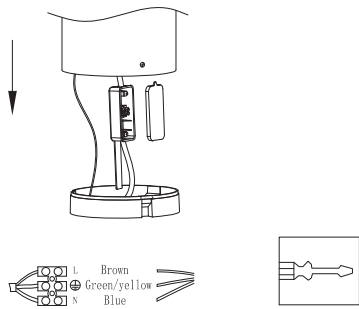

Connect wires

8

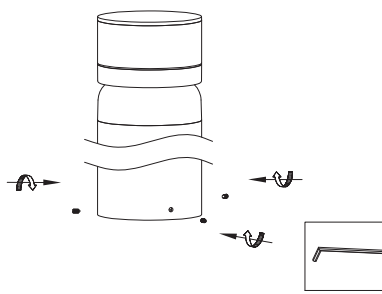

Tie up screws to make it stable

9

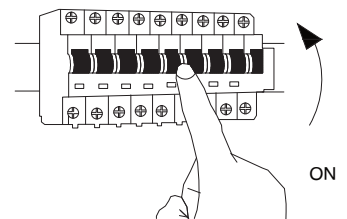

Turn on the general switch

