

NOVA LUCE

9540247

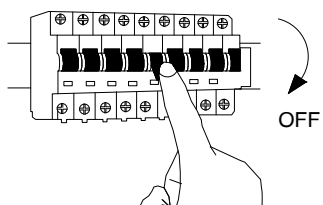

1. Turn off the general switch

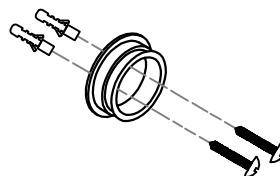

2. Drill holes, apply plastic anchors with screws

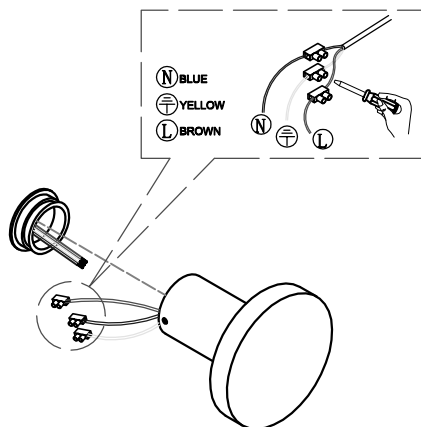

3. Connect the wires & put it in place

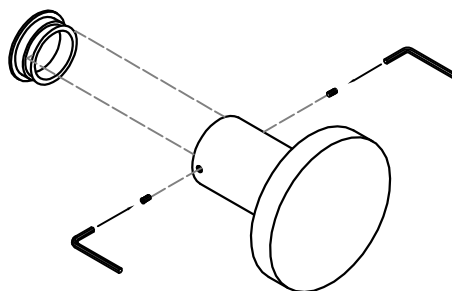

4. Apply side screws to connect parts

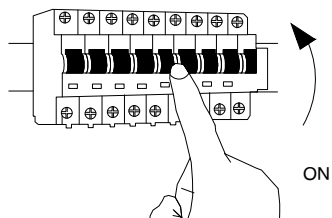

5. Turn on the general switch

