

1

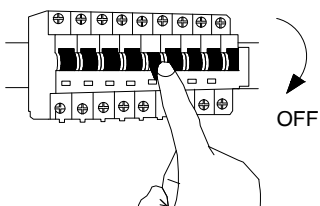

Turn off the general switch

2

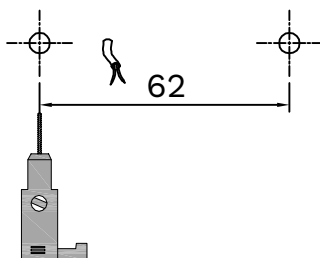

Align Mark & Drill holes

3

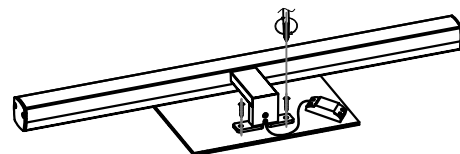

Apply screws

4

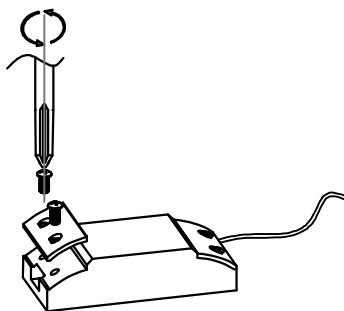

Connect wires

5

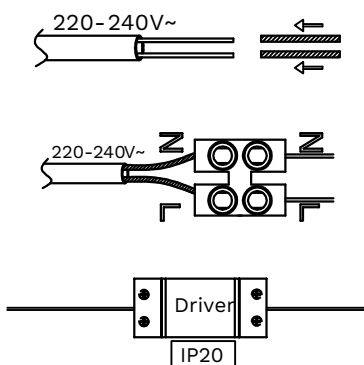

6

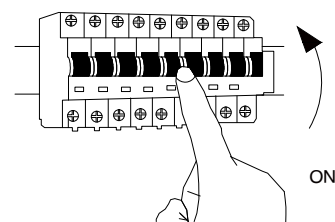

Turn on the general switch

7

ART NR.:787006

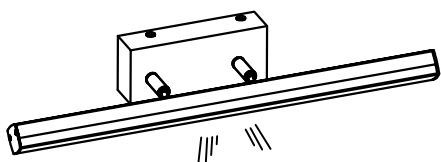

Turn on the light

