

# NOVA LUCE

9091631

1

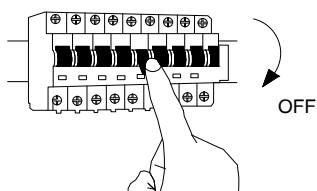

Turn off the general switch

2

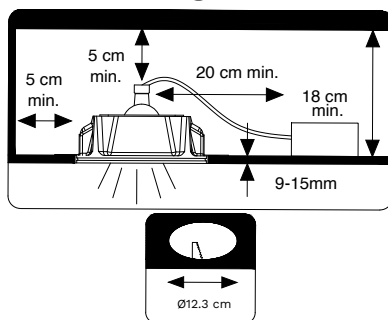

Create a CutOut

3

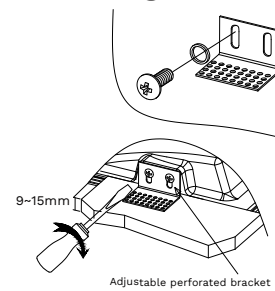

Apply screws to connect the brackets

4

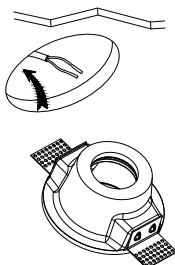

Adjust it into place

5

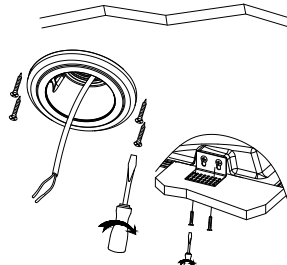

Make brackets stable by tying up screws

6

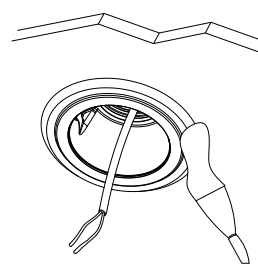

Apply a sealer of your choice

7

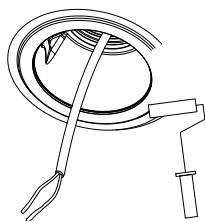

Apply paint of your choice

8

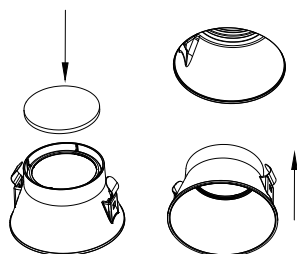

Insert the parts into the Cut Out by rotate

9

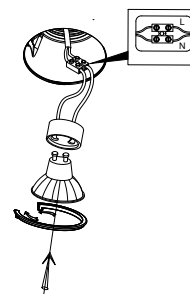

Connect wires & insert bulb

10

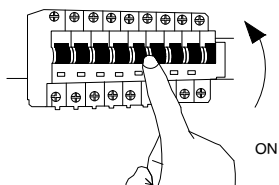

Turn on the general Switch

