

NOVA LUCE

9035978

1

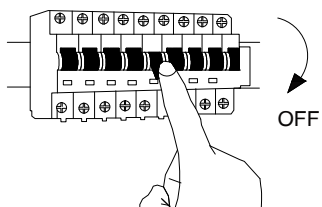

Turn off the general switch

2

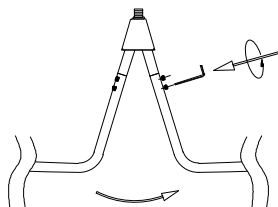

Connect parts together by tying up the screws

3

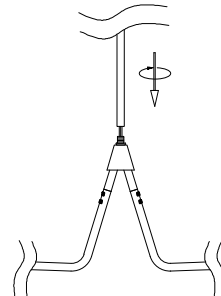

Mark & drill holes
Apply plastic anchors & tie up screws

4

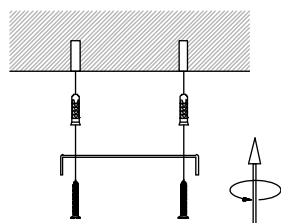

Connect wires

5

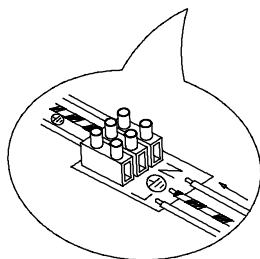

Apply side screws to fix it into place

6

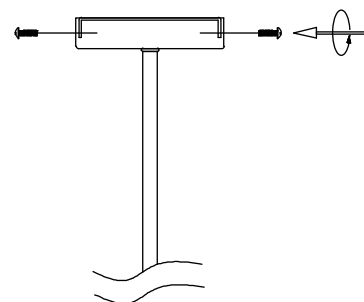

Apply side screws to make it stable

7



Assemble parts together & insert the bulbs by rotate

8

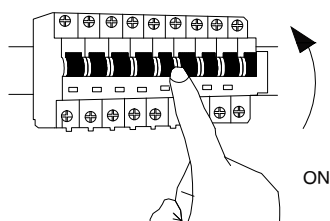

Turn on the general switch

