

NOVA LUCE

9190213

1

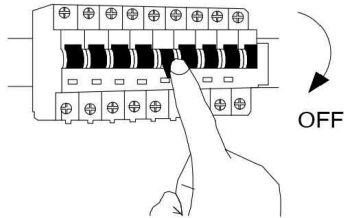

Turn off the general switch

2

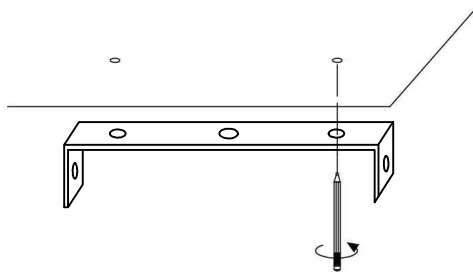

Mark where to drill holes

3

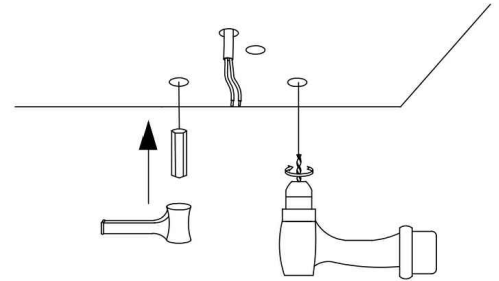

Make holes & apply anchors

4

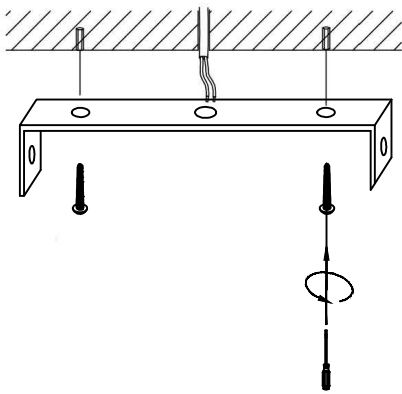

Tie up the screws to make it stable

5

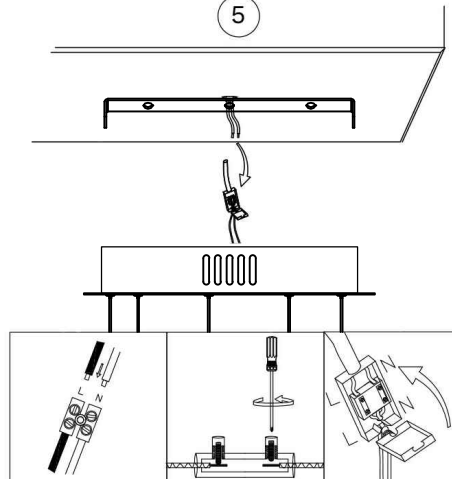

Connect the wires

6

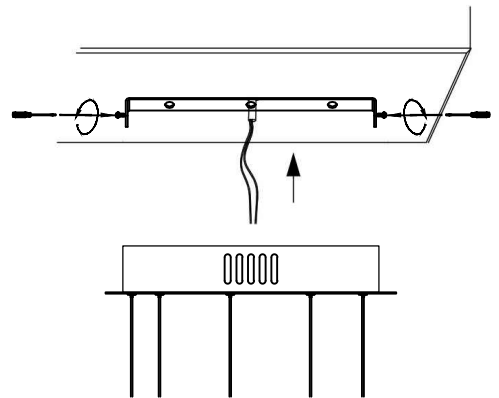

Put the canopy in place & Apply screws

7



Put the glass cover on the aluminum parts

8

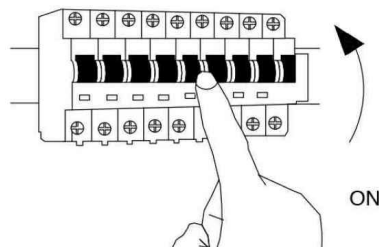

Turn on the general switch

9

