

NOVA LUCE

9030504

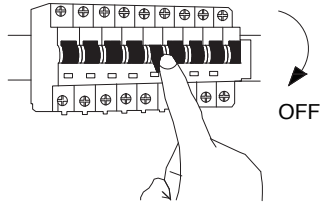

1. Turn off the general switch

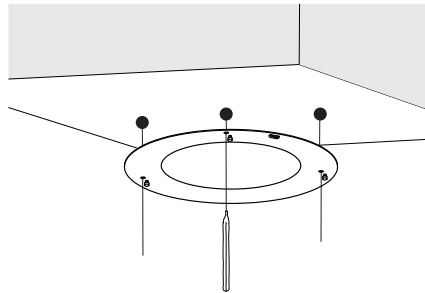

2. Mark the areas

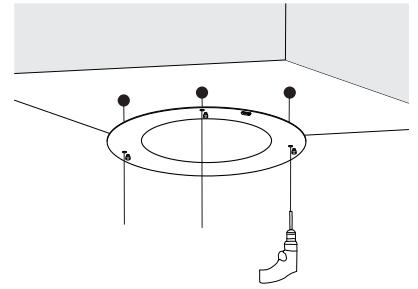

3. Drill on the marked areas

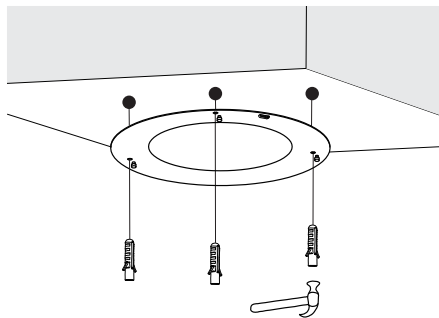

4. Apply plastic anchors

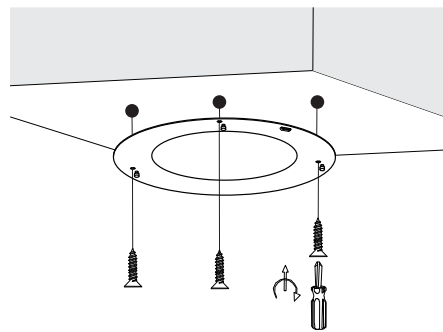

5. Apply screws

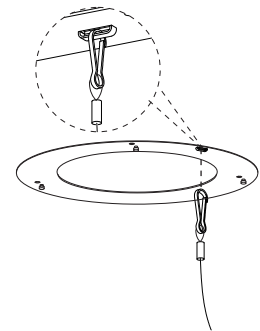

6. Apply the element

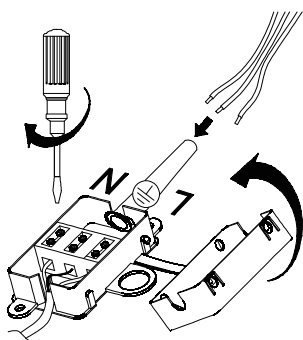

7. Connect the wires

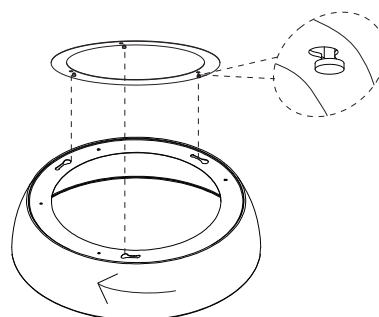

8. Put in place the product

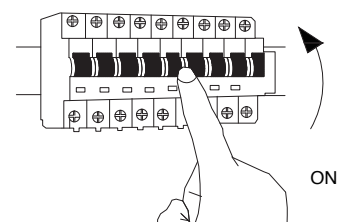

9. Turn on the general switch

