

NOVA LUCE

9190101

1

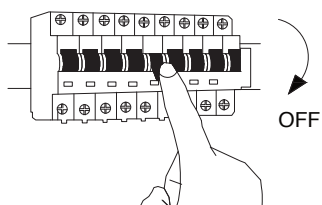

Turn off the general switch

2

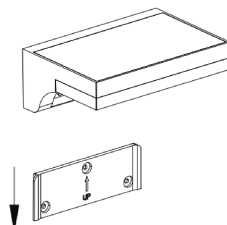

Remove the element

3

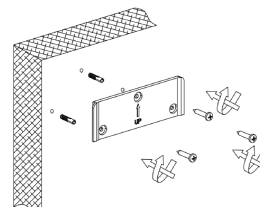

Drill holes & apply plastic anchors
With screws

4

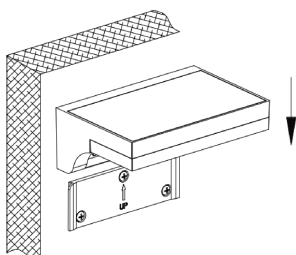

Apply the element in to place

5

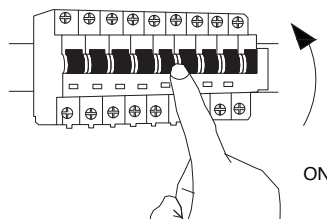

Turn on the general switch

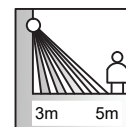
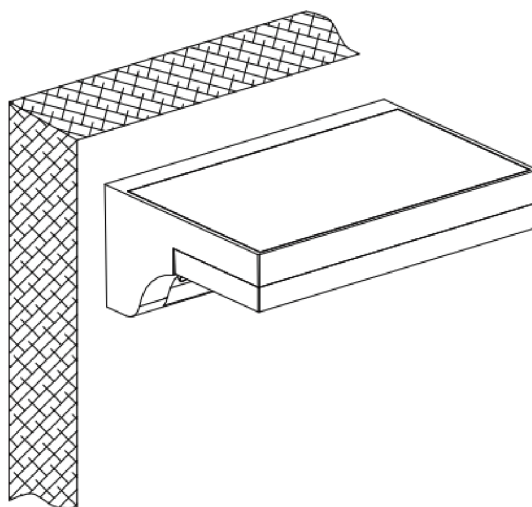

Infrared motions induction,
the induction distance
is about 3-5 meters

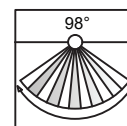

Induction Angle,
around 98 degrees