

NOVA LUCE

9030855

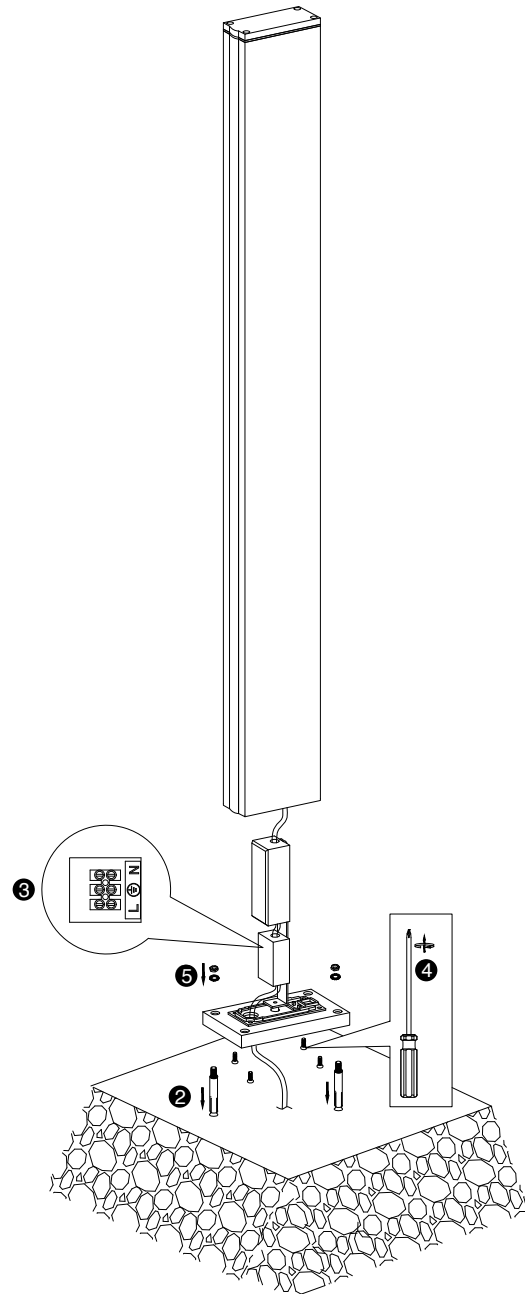
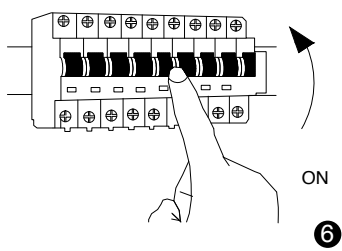
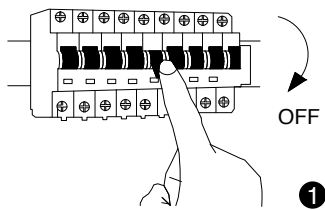

1. Turn off the general switch
2. Drill holes & apply anchors
3. Connect the wires

4. Apply screws to make it stable
5. Apply the ring nut & the washer
6. Turn on the general switch