

NOVA LUCE

61853601

1

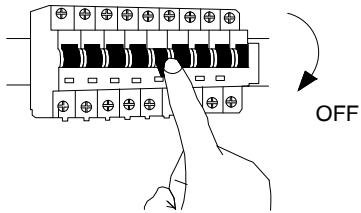

Turn off the general switch

2

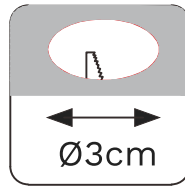

Create a CutOut

3

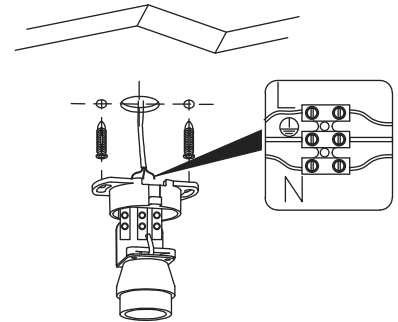

Connect wires

4

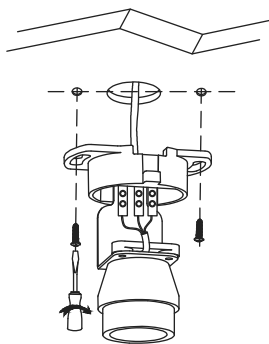

Tie up screws to fix it in place

5

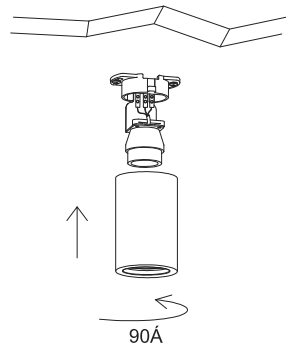

Apply the cap by rotate

6

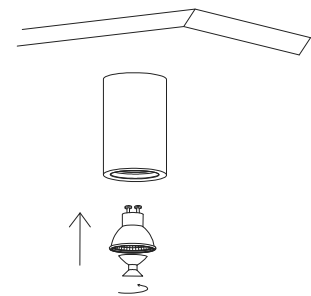

Insert the bulb by rotate

7

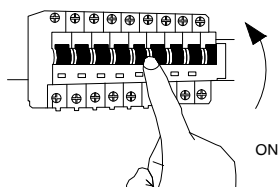

Turn on the general Switch

8

