

NOVA LUCE

9580600 , 9580601

1

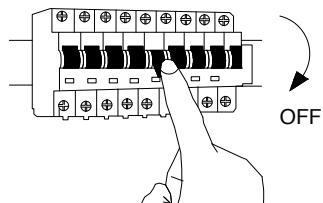

Turn off the general switch

2

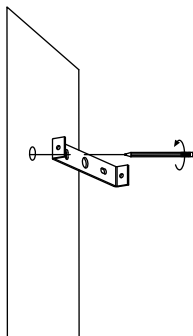

Mark where to drill holes

3

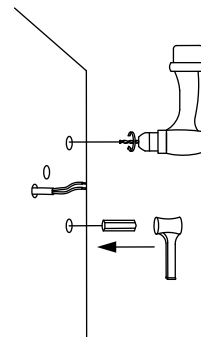

Make holes & apply anchors

4

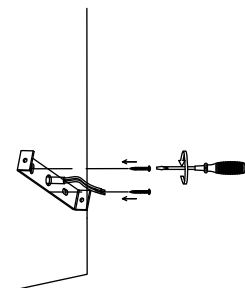

Tie up the screws to make it stable

5

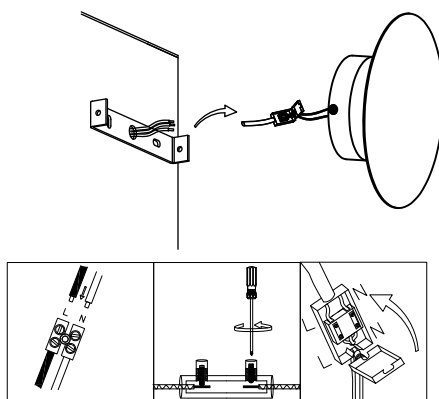

Connect the wires

6

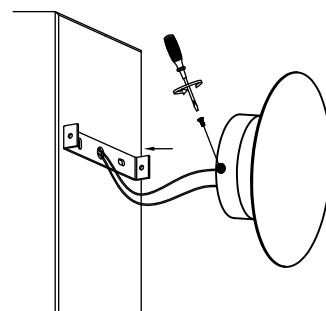

Put it in place & Apply side screws

7

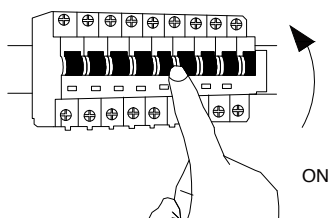

Turn on the general switch

8

