

NOVA LUCE

9756717 / 9756718

1

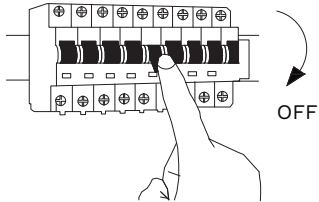

Turn off the general switch

2

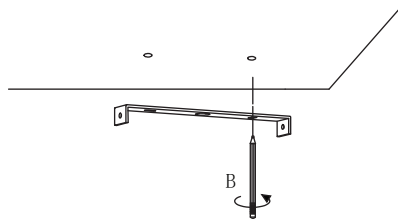

Mark where to drill holes

3

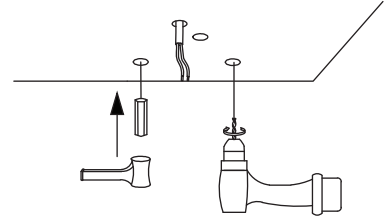

Make holes & apply anchors

4

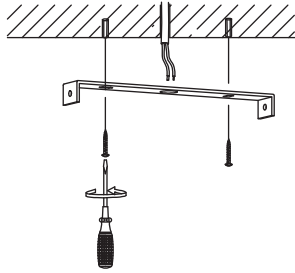

Tie up the screws to make it stable

5

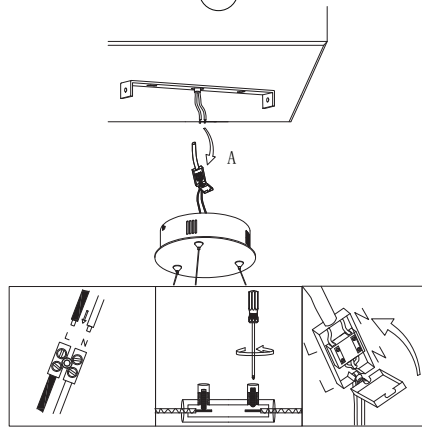

Connect the wires

6

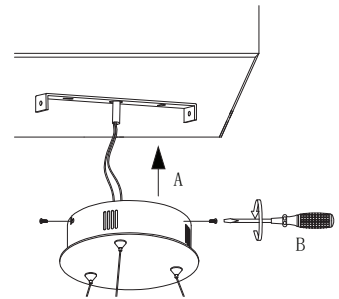

Fix the luminaire into place by tying up the side screws

7

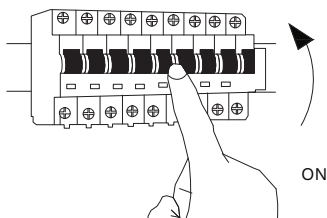

Turn on the general switch



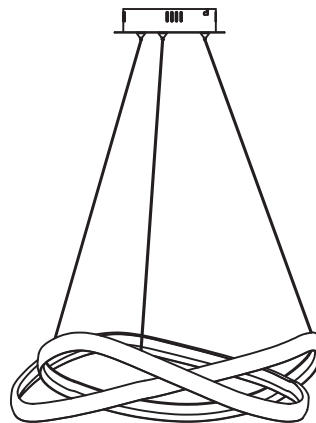



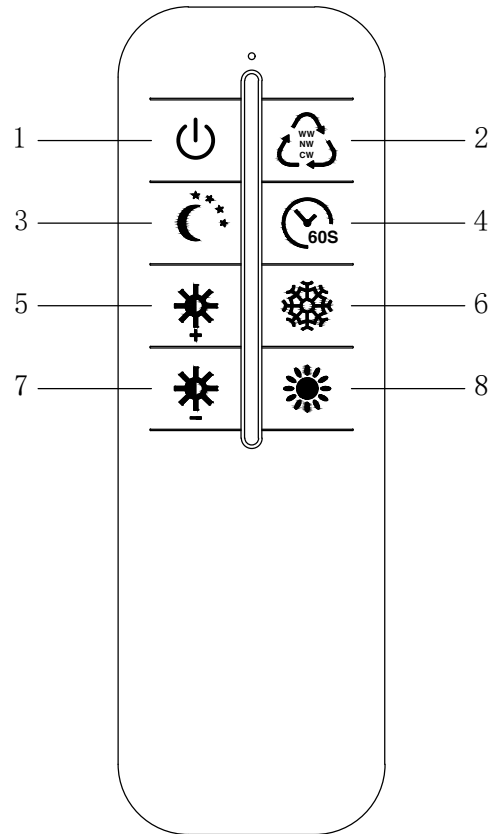

8



NOVA LUCE

2.4G Remote control instructions



1.  ON/OFF switch. Switch on light, within three seconds and press this button once, if the light flash three times, the pairing is successful.
2.  Color temperature switch: Yellow-Warm white-White.
3.  Nightlight mode: 10% brightness of Yellow light.
4.  Timing mode: Switch off the light after 60s.
5.  Brightness +: when the lamp is on, press and hold this button down to increase the brightness.
6.  Color temperature change gradually: Hold down this button, color to White.
7.  Brightness -: when the lamp is on, press and hold this button down to decrease the brightness.
8.  Color temperature change gradually: Hold down this button, color to Yellow.