

1

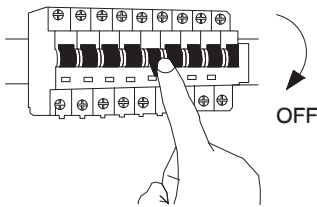

Turn off the general switch

2

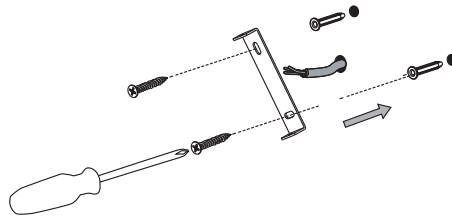

Mark, drill holes
Apply plastic anchors
Tie up screws to make it stable

3

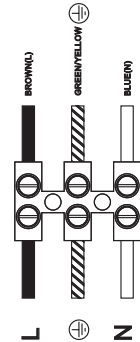

Connect wires

4

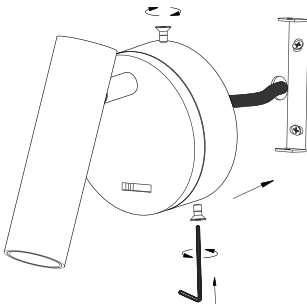

Tie up side screws
to fix it in place

5

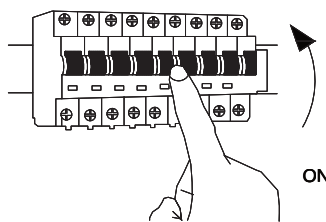

Turn on the general switch

6

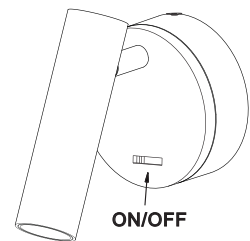

Turn the switch on/ off

7

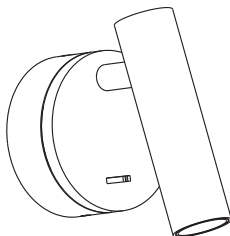

- A. The installation must be done by competent electricians.
- B. Please don't install the lighting in easily damaged, deformed, unsteady ceilings
- C. Make sure the power has been switched off before installation, bulb change or clearing the lamp
- D. Make sure there is no component loose

