

NOVA LUCE

9011608

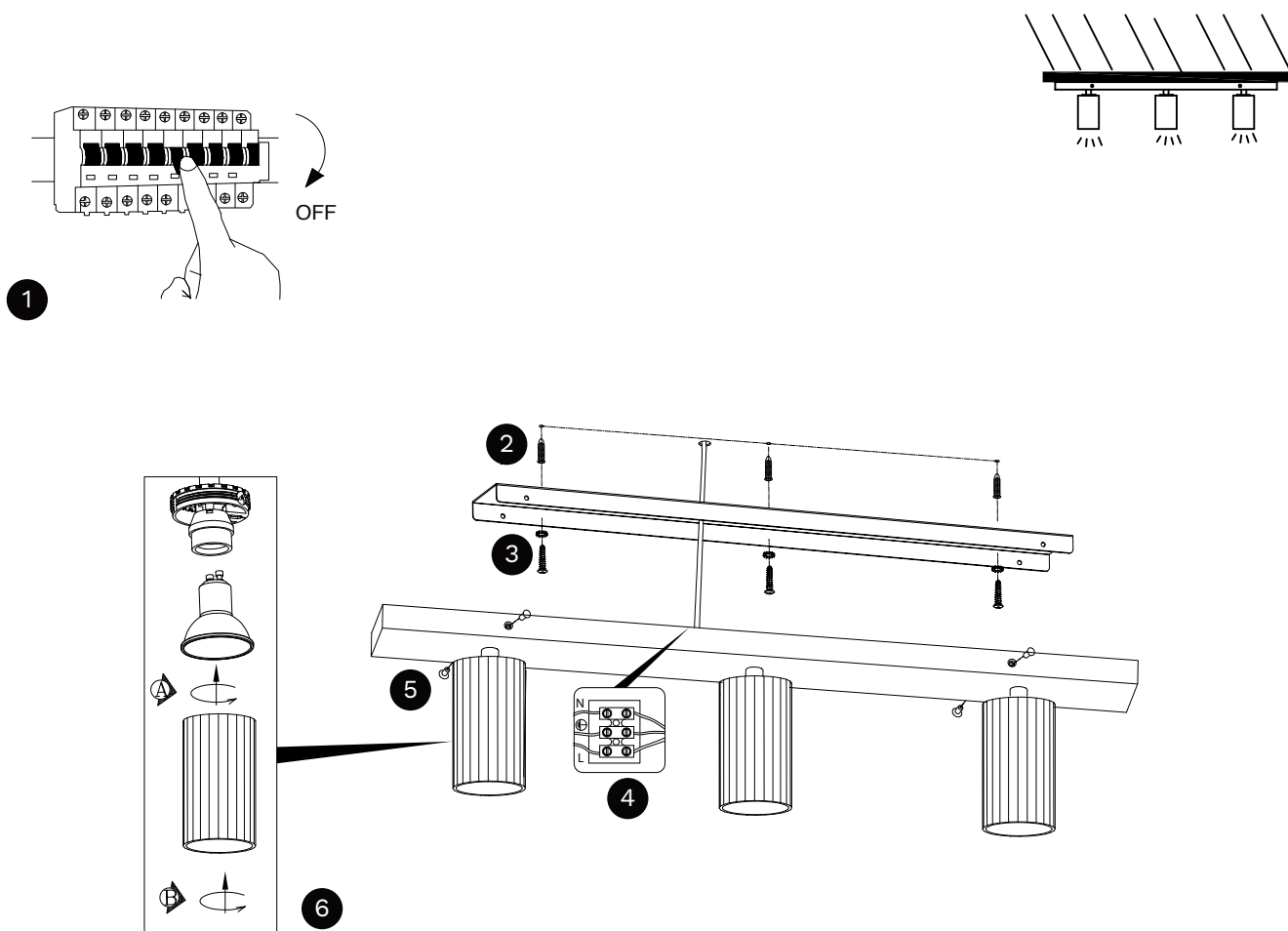

1. Turn off the general switch
2. Drill holes & apply plastic anchors
3. Apply Screws with the elements
4. Connect the wires
5. By rotating apply the screws
6. Apply the element with the bulb
7. Turn on the general switch

