

1. Turn off the general switch

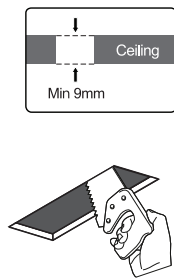

2. Cut out 21 x 3 cm

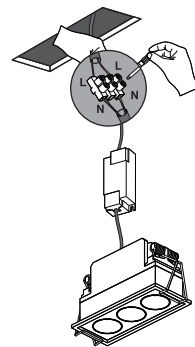

3. Connect the wires

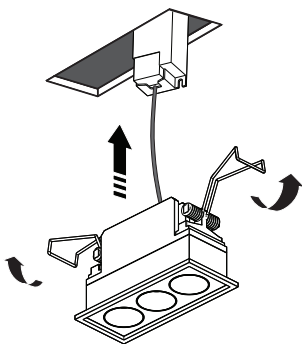

4. Put it in place by pressing
The sides

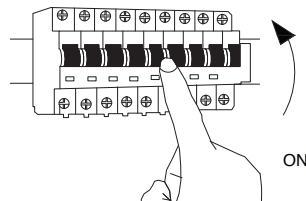

5. Turn on the general switch

