

NOVA LUCE

9260212

1

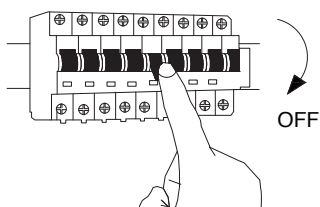

Turn off the general switch

2

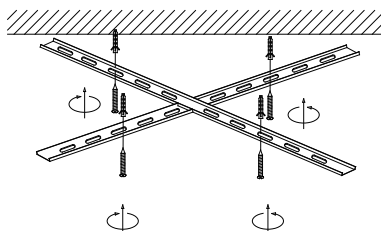

Align, mark and drill holes to apply the screws

3

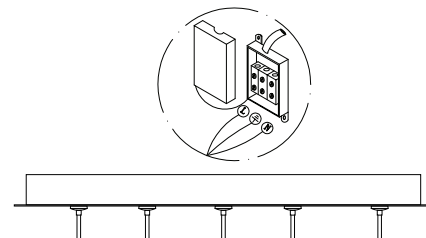

Connect the wires

4

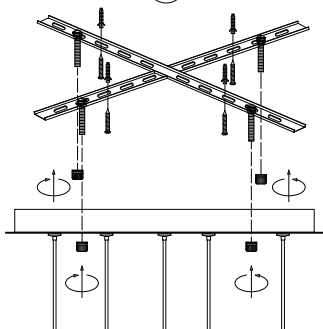

Apply the cap nuts

5

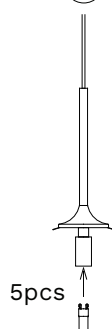

Insert the bulb

6

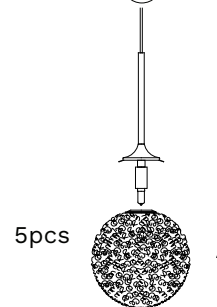

Apply the glass by rotating

7

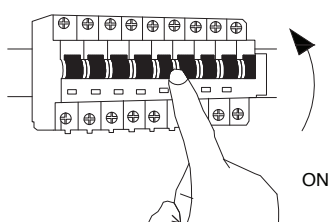

Turn on the general switch

