

1

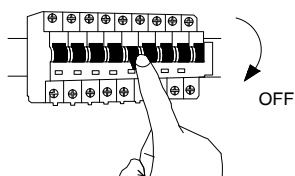

Turn off the general switch

2

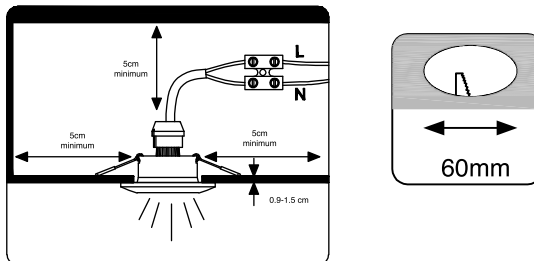

Create a CutOut

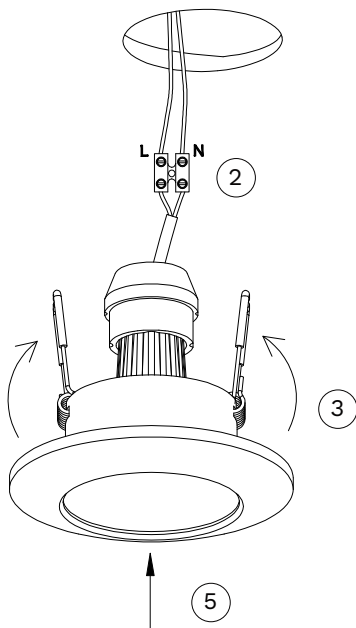
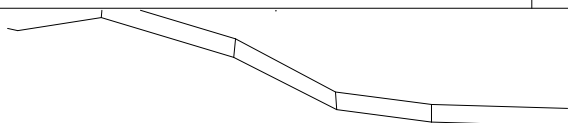

4

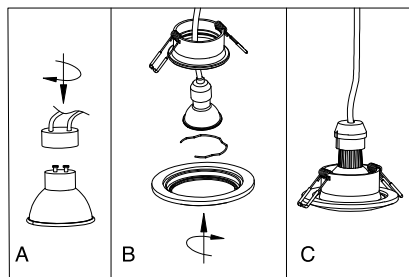

2. Connect wires

3. Press the brackets together to put it in place

4. Insert the bulb by following the steps

5. Adjust it in place

6

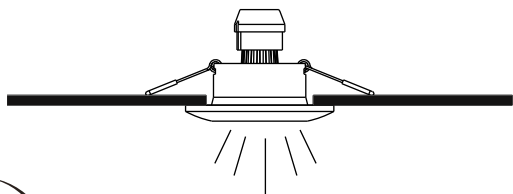

7

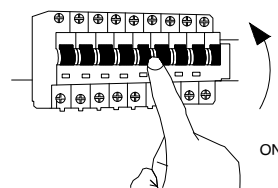

Turn on the general Switch